

NOVASTACK® 35-P

Robust connector with hold-down feature and Corson Alloy main contact to transmit power lines, 0.35 mm pitch, 0.7 mm height, 2.3 mm depth

Product Specifications:

Board Pitch (mm)		0.35
Wiping Length (mm)		0.19 (10~50 P), 0.13 (52~80 P)
Mated Size (mm)	Height	0.7+/-0.1
	Width	Formula: $2.17 + (0.35 * ?p/2)$
	Depth	2.3
Current Rating	Signal	0.3 A/pin
	Power	2.0 A/pin x 2
Pin Counts	Range	10 - 80 (signal) + 2 (power)
	Available	10, 14, 18, 20, 24, 30, 34, 40, 50, 60

* Please inquire for pin counts not listed or outside of the pin count range.

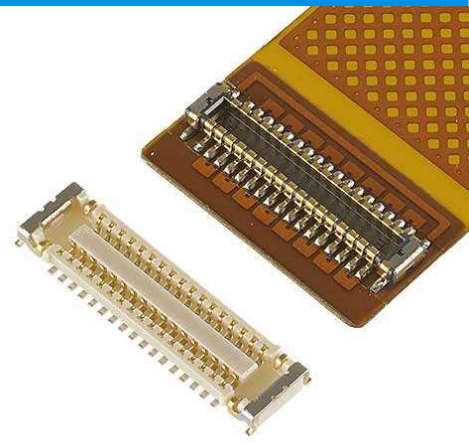

▶ Hold down feature can be a 2 A x 2 terminal for power supply

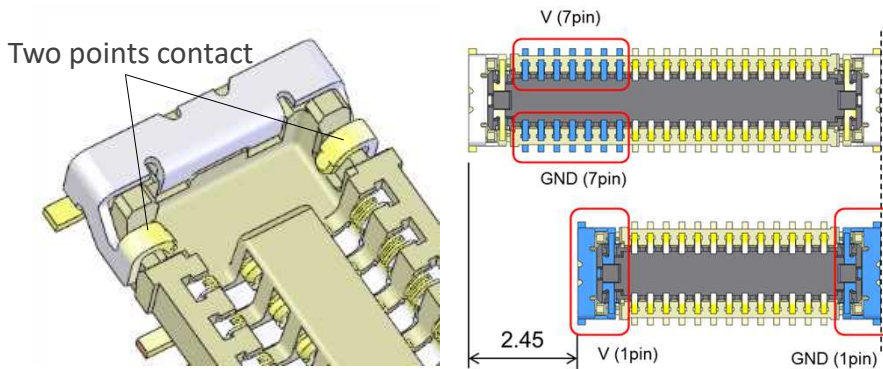

2 A/pin power pin minimizes total pin count and length

▶ Metal guide for easy operation

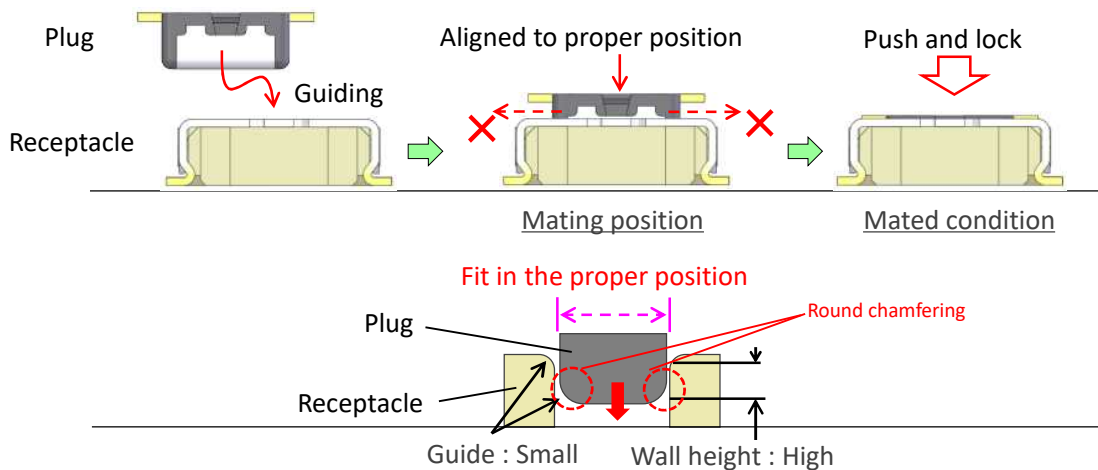

▶ High robustness with metal hold-down feature

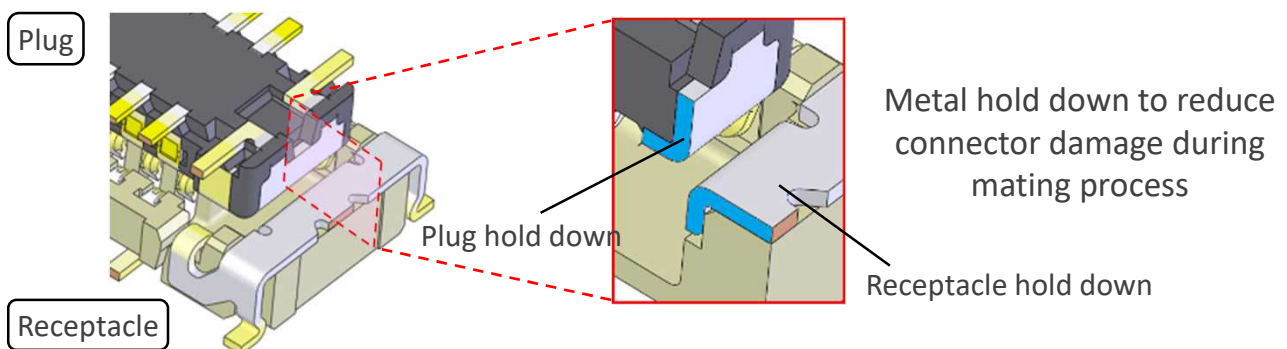

Component Parts Details

Plug Assembly

Recommended P/N 20708-0**E-01-□

PART No.	Pos.	A	B	C	D	E	PART No. 20708-0**E-##-□	CONDUCTIVITY TYPE (#)	QTY. IN REEL (□)	APPLICABLE POSITION NUMBER (**)									
20708-010E-##-□	10	1.40	2.42	3.06	3.92	-	20708-0**E	NORMAL(NONE)	20,000(NONE)	-	-	-	-	-	34	40	50	-	
20708-014E-##-□	14	2.10	3.12	3.76	4.62	-	20708-0**E-00-M	NORMAL(00)	5,000(M)	-	-	-	-	-	34	40	50	-	
20708-018E-##-□	18	2.80	3.82	4.46	5.32	-	20708-0**E-01	HIGH(01)	20,000(NONE)	10	14	18	20	24	30	34	40	50	60
20708-020E-##-□	20	3.15	4.17	4.81	5.67	-	20708-0**E-01-M	HIGH(01)	5,000(M)	10	14	18	20	24	30	34	40	50	60
20708-024E-##-□	24	3.85	4.87	5.51	6.37	-													
20708-030E-##-□	30	4.90	5.92	6.56	7.42	-													
20708-034E-##-□	34	5.60	6.62	7.26	8.12	-													
20708-040E-##-□	40	6.65	7.67	8.31	9.17	-													
20708-050E-##-□	50	8.40	9.42	10.06	10.92	-													
20708-060E-##-□	60	10.15	11.17	11.81	12.67	2.26													

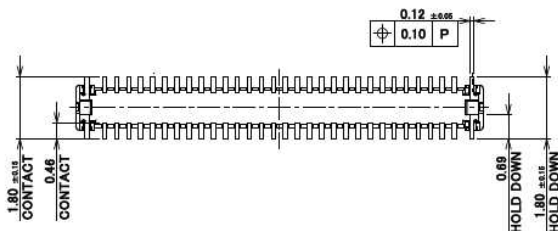
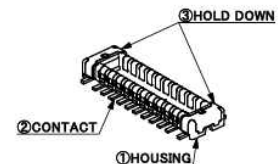
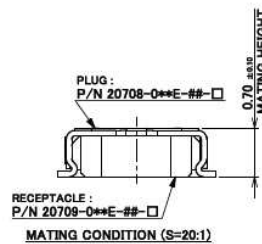
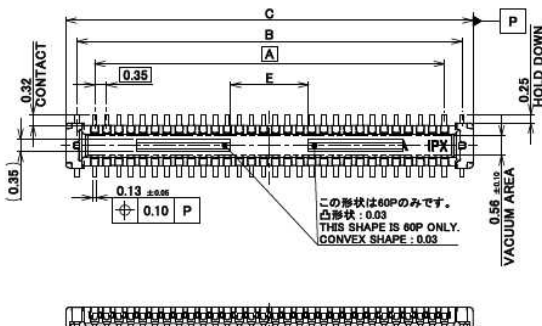

3	HOLD DOWN	CORSON ALLOY	ALL OVER Ni 1.27 μm MIN. CONTACT PART Au 0.1 μm MIN. SOLDERING PART Au 0.01 μm MIN.
2	CONTACT	PHOSPHOR BRONZE P/N : 20708-0**E CORSON ALLOY P/N : 20708-0**E-00-M P/N : 20708-0**E-01-□	ALL OVER Ni 1.27 μm MIN. CONTACT PART Au 0.1 μm MIN. SOLDERING PART Au 0.01 μm MIN.
1	HOUSING	LCP	UL94V-0, BLACK
NO.	DISCRIPTION	MATERIAL	FINISH , REMARKS

Plug Assembly

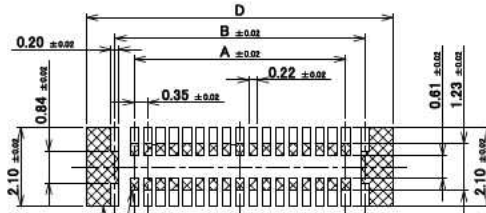

半田上がり防止の為、半田付けをしないで下さい。
 パターンを敷けるときは、レジストもしくはカバーレイを敷けて下さい。
 MUST BE NOT SOLDERING AREA FOR PREVENT FROM SOLDER WICKING.
 MUST BE COVER LAY OR RESIST COATING ON THE PATTERN.

RECOMMENDED PATTERN LAYOUT

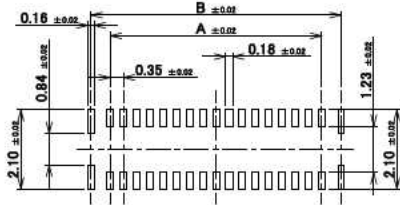

RECOMMENDED METAL MASK LAYOUT
 THICKNESS : 0.10 mm

ホールドダウンを電源用としてご使用の場合は、
 両パットを面のように繋げて下さい。
 PAD IS CONNECTED LIKE FIGURE WHEN HOLD DOWN
 IS USED FOR POWER SUPPLY.

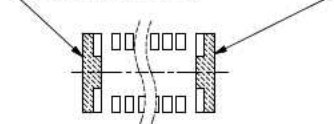

HOLD DOWN PAD LAYOUT
 USED FOR POWER SUPPLY.

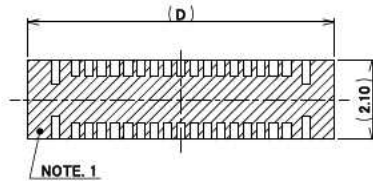

NOTE. 1

NOTES.
 1. THIS AREA CANNOT MOUNT ANOTHER COMPONENTS.

Rev.13

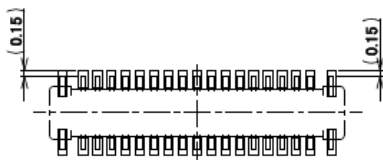

CONNECTOR ON RECOMMENDED FOOTPRINT PATTERN

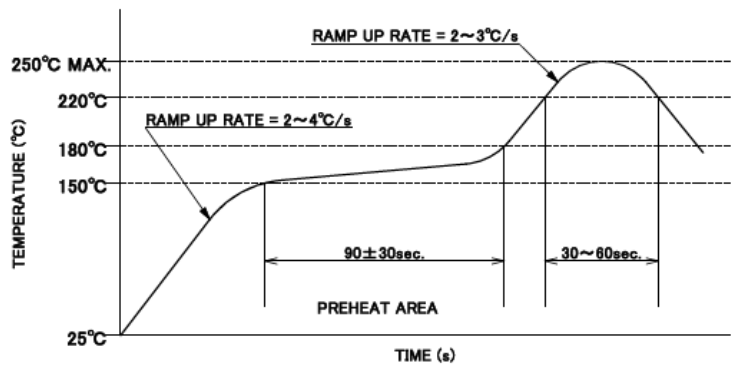

REFLOW TEMPERATURE PROFILE
 SENJU METAL INDUSTRY CO., LTD. : M705-SHF(Sn96.5 Ag3.0 Cu0.5)

Plug Assembly

ITEMS	SPECIFICATION	
	NORMAL CONDUCTIVITY	HIGH CONDUCTIVITY
APPLICABLE CONNECTOR PART No.	20709-0**E-***	
RATING VOLTAGE	50V AC (r.m.s) / DC	
RATING AMPERAGE (FOR SIGNAL CONTACT)	0.3A AC/DC (PER CONTACT PIN), 12.0A AC/DC(TOTAL)	0.3A AC/DC (PER CONTACT PIN), 12.0A AC/DC(TOTAL) 1.0A AC/DC (PER CONTACT OF UP TO 8 PINS)
RATING AMPERAGE (FOR POWER CONTACT)	2.0A AC/DC (PER CONTACT PIN), 4.0A AC/DC(TOTAL)	
OPERATING TEMPERATURE	233~358K(-40°C~+85°C)	
OPERATING HUMIDITY	85% MAX.(NON-CONDENSING)	
CONTACT RESISTANCE (FOR SIGNAL CONTACT)	INITIAL : 80mohm MAX. / AFTER TEST : Δ 20mohm MAX.	INITIAL : 30mohm MAX. / AFTER TEST : Δ 20mohm MAX.
CONTACT RESISTANCE (FOR POWER CONTACT)	INITIAL : 80mohm MAX. / AFTER TEST : Δ 20mohm MAX.	
INSULATION RESISTANCE	INITIAL : 1,000Mohm MIN. / AFTER TEST : 500Mohm MIN.	
DIELECTRIC WITHSTANDING VOLTAGE	AC200V 1min	
DURABILITY	20 CYCLES	
MATING FORCE (INITIAL)	1.0 N/Pin MAX.	~28P 2.0 N/Pin MAX. 30P~ 1.0 N/Pin MAX.
UNMATING FORCE (AFTER TEST)	0.15 N/Pin MIN.	~28P 0.30 N/Pin MIN. 30P~ 0.15 N/Pin MIN.
COPLANARITY	0.08 MAX.	
PRODUCT SPECIFICATION	PRS-2101	PRS-2334
TEST REPORT	TR-15069	TR-16143
PACKING STANDARD	PST-15076 (20K/REEL) PST-17038 (5K/REEL)	
INSTRUCTION MANUAL	HIM-15014	
APPEARANCE CRITERIA No.	QLS-A***	

Rev.13

Receptacle Assembly

Recommended P/N 20709-0**E-01-□

PART No.	Pos	A	B	C	D	E	F	PART No.	CONDUCTIVITY TYPE (#)	QTY. IN REEL (□)	APPLICABLE POSITION NUMBER (**)											
											10	14	18	20	24	30	34	40	50	60		
20709-010E-##-□	10	1.40	3.92	3.75	2.70	4.10	-	20708-0**E-##-□	NORMAL(NONE)	20,000(NONE)	-	-	-	-	-	34	40	50	-			
20709-014E-##-□	14	2.10	4.62	4.45	3.40	4.80	-	20709-0**E-00-M	NORMAL(00)	5,000(M)	-	-	-	-	-	34	40	50	-			
20709-018E-##-□	18	2.80	5.32	5.15	4.10	5.50	-	20709-0**E-01	HIGH(01)	20,000(NONE)	10	14	18	20	24	30	34	40	50	60		
20709-020E-##-□	20	3.15	5.67	5.50	4.45	5.85	-	20709-0**E-01-M	HIGH(01)	5,000(M)	10	14	18	20	24	30	34	40	50	60		
20709-024E-##-□	24	3.85	6.37	6.20	5.15	6.55	-															
20709-030E-##-□	30	4.90	7.42	7.25	6.20	7.60	-															
20709-034E-##-□	34	5.60	8.12	7.95	6.90	8.30	-															
20709-040E-##-□	40	6.65	9.17	9.00	7.95	9.35	-															
20709-050E-##-□	50	8.40	10.92	10.75	9.70	11.10	-															
20709-060E-##-□	60	10.15	12.67	12.50	11.45	12.85	2.10															

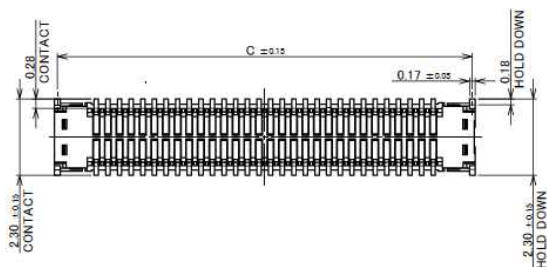
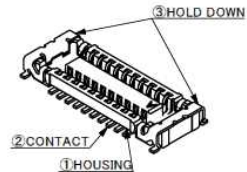
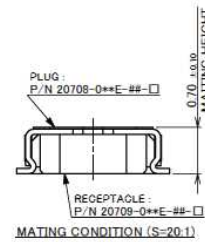
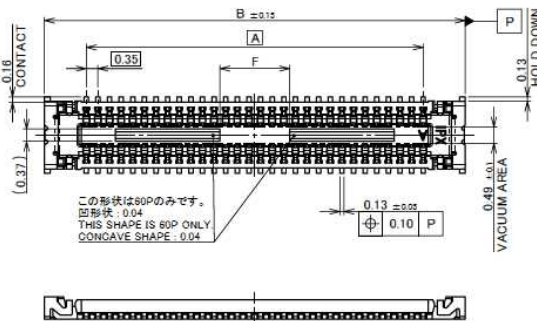

3	HOLD DOWN	CORSON ALLOY	ALL OVER Ni 1.27 μ m MIN. CONTACT PART Au 0.1 μ m MIN / SOLDERING PART Au 0.01 μ m MIN.
2	CONTACT	PHOSPHOR BRONZE P/N : 20709-0**E CORSON ALLOY P/N : 20709-0**E-00-M P/N : 20709-0**E-01-□	ALL OVER Ni 1.27 μ m MIN. CONTACT PART Au 0.1 μ m MIN / SOLDERING PART Au 0.01 μ m MIN.
1	HOUSING	LCP	UL94V-0, BEIGE
NO	DISCRIPTION	MATERIAL	FINISH , REMARKS

Rev.14

Receptacle Assembly

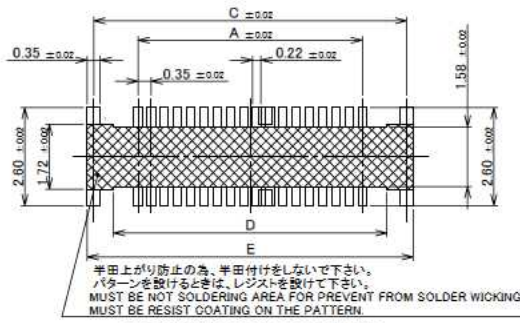

RECOMMENDED PATTERN LAYOUT

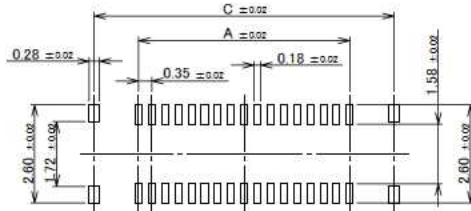

RECOMMENDED METAL MASK LAYOUT
 THICKNESS : 0.10 mm

ホールドダウンを電源用としてご使用の場合は、
 両パットを逆のように繋げて下さい。
 PAD IS CONNECTED LIKE FIGURE WHEN HOLD DOWN
 IS USED FOR POWER SUPPLY.

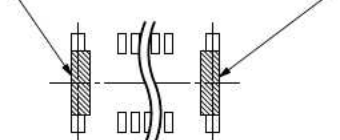

HOLD DOWN PAD LAYOUT
 USED FOR POWER SUPPLY

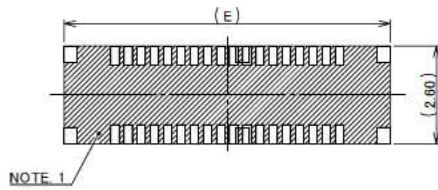

NOTES
 1. THIS AREA CANNOT MOUNT ANOTHER COMPONENTS.

Rev.14

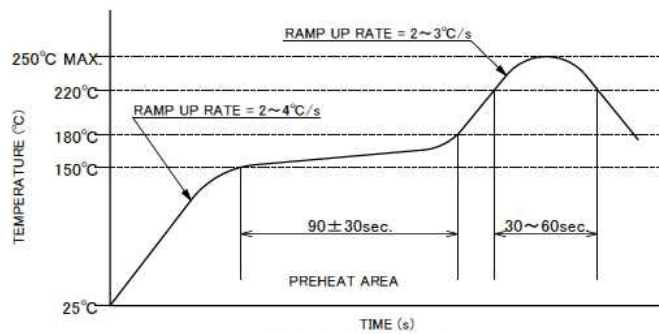

REFLOW TEMPERATURE PROFILE
 SENJU METAL INDUSTRY CO., LTD. · M705-SHF(Sn96.5 Ag3.0 Cu0.5)

Receptacle Assembly

ITEMS	SPECIFICATION	
	NORMAL CONDUCTIVITY	HIGH CONDUCTIVITY
APPLICABLE CONNECTOR PART No.	20708-0**E-**	
RATING VOLTAGE	50V AC (r.m.s) / DC	
RATING AMPERAGE (FOR SIGNAL CONTACT)	0.3A AC/DC (PER CONTACT PIN), 12.0A AC/DC(TOTAL)	0.3A AC/DC (PER CONTACT PIN), 12.0A AC/DC(TOTAL) 1.0A AC/DC (PER CONTACT OF UP TO 8 PINS)
RATING AMPERAGE (FOR POWER CONTACT)	2.0A AC/DC (PER CONTACT PIN), 4.0A AC/DC(TOTAL)	
OPERATING TEMPERATURE	233~358K(-40°C~+85°C)	
OPERATING HUMIDITY	85% MAX.(NON-CONDENSING)	
CONTACT RESISTANCE (FOR SIGNAL CONTACT)	INITIAL : 80mohm MAX. / AFTER TEST : Δ 20mohm MAX.	INITIAL : 30mohm MAX. / AFTER TEST : Δ 20mohm MAX.
CONTACT RESISTANCE (FOR POWER CONTACT)	INITIAL : 80mohm MAX. / AFTER TEST : Δ 20mohm MAX.	INITIAL : 30mohm MAX. / AFTER TEST : Δ 20mohm MAX.
INSULATION RESISTANCE	INITIAL : 1.000Mohm MIN. / AFTER TEST : 500mohm MIN.	
DIELECTRIC WITHSTANDING VOLTAGE	AC200V 1min	
DURABILITY	20 CYCLES	
MATING FORCE (INITIAL)	1.0 N/Pin MAX.	~28P 2.0 N/Pin MAX. 30P~ 1.0 N/Pin MAX.
UNMATING FORCE (AFTER TEST)	0.15 N/Pin MIN.	~28P 0.30 N/Pin MIN. 30P~ 0.15 N/Pin MIN.
COPLANARITY	0.08 MAX.	
PRODUCT SPECIFICATION	PRS-2101	PRS-2334
TEST REPORT	TR-15069	TR-16143
PACKING STANDARD	PST-15077 (20K/REEL) PST-17039 (5K/REEL)	
INSTRUCTION MANUAL	HIM-15014	
APPEARANCE CRITERIA No.	QLS-A***	

Rev.14

Board to Board



High-Density



Autolocking FPC/FFC

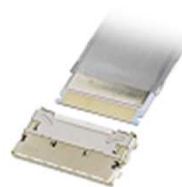

High-Density



FPC/FFC



Micro-Coaxial / Discrete Cable



High-Speed



RF



High-Frequency



Optical Module



High-Speed



Effector



Power



High-Power



I/O (Input/Output)



Quick charge



Inquiry



Custom Connectors Available



I-PEX, MHF, CABLINE, NOVASTACK, EVAFFLEX, MINIFLEX, ISH, IARPB, IASLP, ESTORQ, ISFIT, i-Fit and ZenShield are registered trademarks of I-PEX Inc. Please note that the contents in the catalog might be changed without prior notification. I-PEX Inc. assumes no responsibility for any inaccuracies or obligation to update information on these documents. Please be sure to read and understand the latest "Precautions for Use" and "Instruction Manual" before you use our products. We shall not be responsible for any defects, damages or troubles in case you use our products without following the precautions for use. Please feel free to contact our sales representatives when you use our products for any applications that require very high reliability and safety, or that relate to human life (ex. nuclear power control, aerospace, transportation, medical equipment, safety equipment etc.).

Contact your sales representative or more detailed information.

www.i-pex.com



I-PEX

© I-PEX Inc. 2022
All rights reserved.